

REV	ECN No.	DESCRIPTION	DESIGN	DATE
A0		Release	蒋建银	2017.09.22

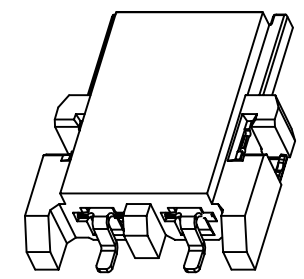
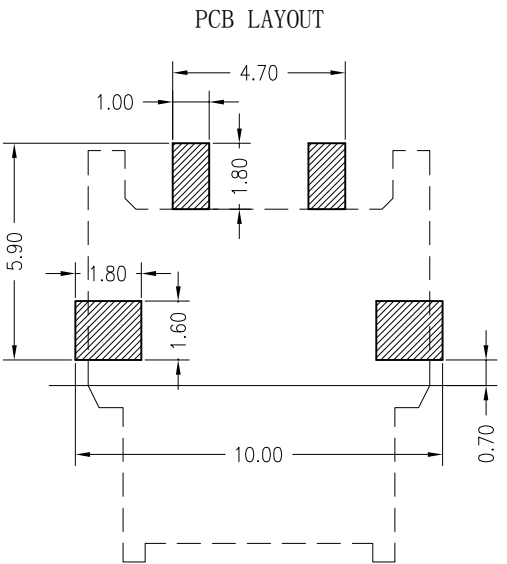
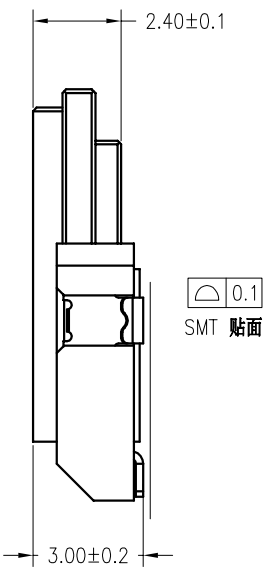
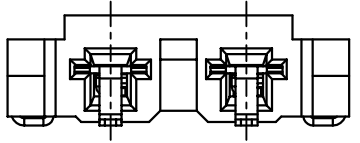
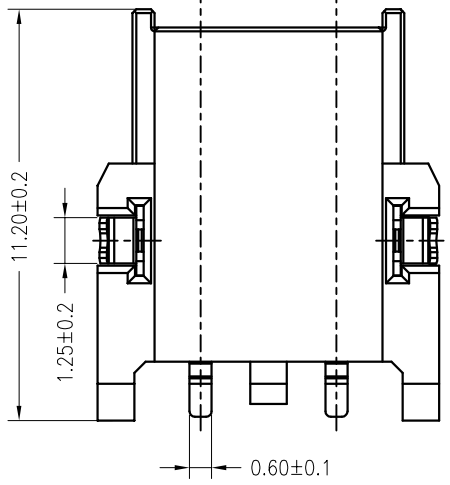
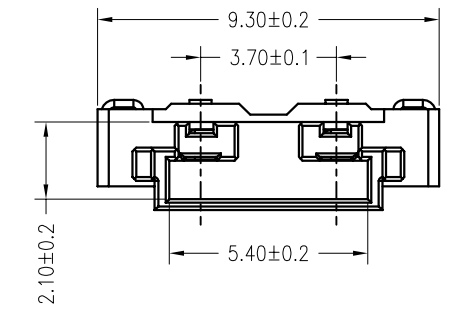

主要技术参数 Main Specifications

- 线 数 (Poles): 02
- 接触电阻 (Contact resistance): $\leq 30m\Omega$
- 绝缘电阻 (Insulation resistance): $\geq 1000M\Omega$
- 额定电压 (Rated voltage): 500V AC DC
- 额定电流 (Rated current): 2A AC DC
- 耐 电压 (Withstand Voltage): 1500V AC/minute
- 温度范围 (Temperature Range): $-40^{\circ}C \sim +85^{\circ}C$

ORDER INFORMATION:

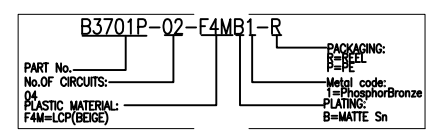

ITEM	COMPONENT	Q'TY	MATERIAL	FINISH
C	COLDER TAB	2 PCS	PhosphorBronze	MATTE Sn
B	CONTACT	2 PCS	PhosphorBronze	MATTE Sn
A	HOUSING	1 PCS	LCP	UL 94V-0, COLOR:BEIGE

JKUN 温州健坤接插件有限公司
WENZHOU JKUN CONNECTOR CO., LTD.

TITLE: -
 3.7mm PITCH 90° WAFER SMT TYPE

X.±0.5	X.±5'	USE:	CUSTOMER
.X±0.3	.X±2'	APPD:	
.XX±0.25	.XX±1'	CHKD:	谭龙清
--	--	DR:	田峰
⊕	◁	UNITS:	蒋建银
		mm	

PART NO.:	B3701P-02-F4MB1-R
DWG NO.:	JKUN-GCCP-0743
SCALE	1 : 1
SHEET	1 / 1