

| REV | DESCRIPTION | DESIGN     | DATE       |
|-----|-------------|------------|------------|
| A   | NEW RELEASE | FangSongLe | 2020/12/09 |

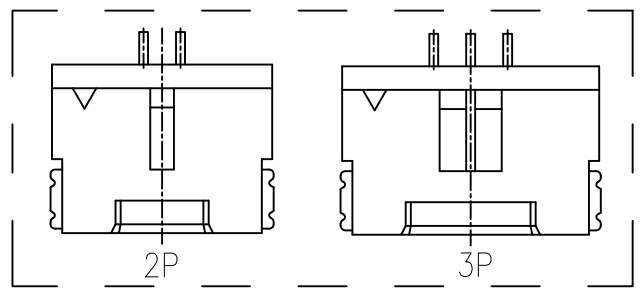

Specifications:  
 Poles: 2 to 30  
 Contact resistance:  $\leq 30m\Omega$   
 Insulation resistance:  $\geq 500M\Omega$   
 Rated voltage: 150V AC DC  
 Rated current: 1A AC DC  
 Withstand Voltage: 500V AC/minute  
 Temperature Range:  $-25^{\circ}C \sim +85^{\circ}C$   
 Housing: PA9T UL94V-0, Natural  
 Contacts: Brass/ MATTE Sn-plated  
 Solder tabs: Brass/MATTE Sn-plated

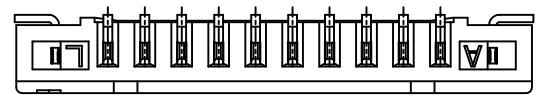
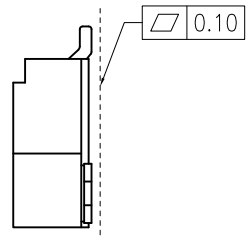
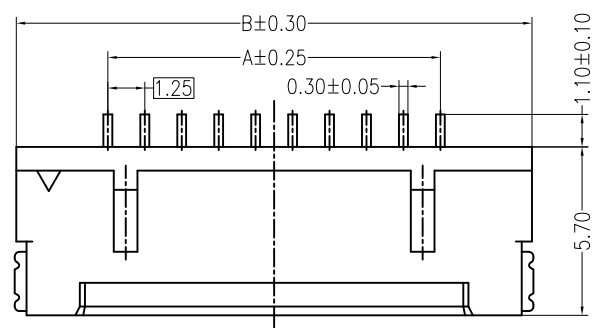

ORDER INFORMATION:

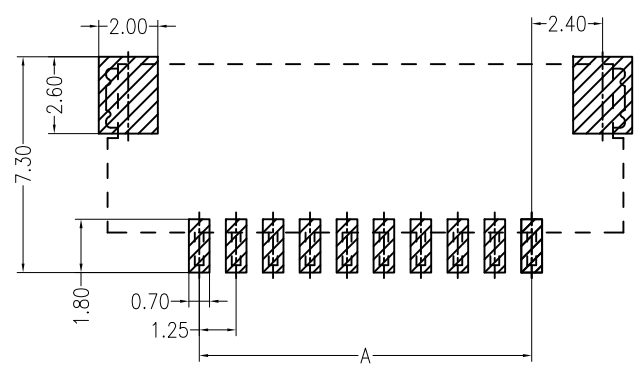
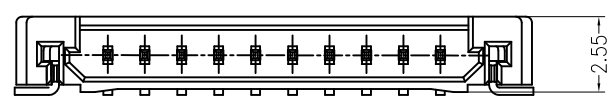
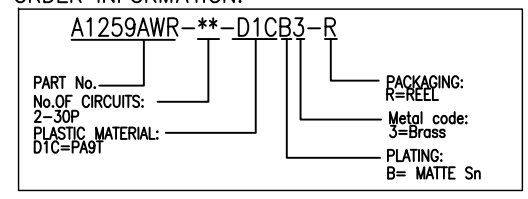

PCB LAYOUT(Tolerance:  $\pm 0.05$ )

| PIN  | DIM A | DIM B | PIN  | DIM A | DIM B |
|------|-------|-------|------|-------|-------|
| 2P   | 1.25  | 7.45  | *12P | 13.75 | 19.95 |
| 3P   | 2.50  | 8.70  | *13P | 15.00 | 21.20 |
| 4P   | 3.75  | 9.95  | *14P | 16.25 | 22.45 |
| 5P   | 5.00  | 11.20 | 15P  | 17.50 | 23.70 |
| *6P  | 6.25  | 12.45 | *20P | 23.75 | 29.95 |
| *7P  | 7.50  | 13.70 | *21P | 25.00 | 31.20 |
| *8P  | 8.75  | 14.95 | 25P  | 30.00 | 36.20 |
| *9P  | 10.00 | 16.20 | 30P  | 36.25 | 42.45 |
| 10P  | 11.25 | 17.45 |      |       |       |
| *11P | 12.50 | 18.70 |      |       |       |

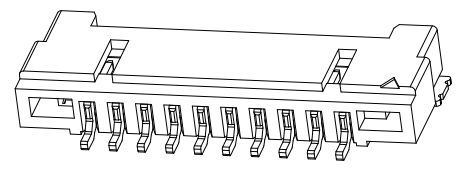

|  |                      |                                    |                     |
|--|----------------------|------------------------------------|---------------------|
| <b>JKUN</b> 温州健坤接插件有限公司<br>WENZHOU JKUN CONNECTOR CO.,LTD. |                      | TITLE:<br>1.25 Pitch Wafer 90° SMT |                     |
| GENERAL TOLERANCE  |                      | USE:                               | PART NO.:           |
| X. $\pm 0.50$  | X. $\pm 5^{\circ}$   | CUSTOMER                           | A1259AWR-**-D1CB3-R |
| X.X $\pm 0.30$   | X.X $\pm 2^{\circ}$  | APPD:<br>Liuzhengling              | DWG NO.:            |
| X.XX $\pm 0.20$  | X.XX $\pm 1^{\circ}$ | CHKD:<br>Steven                    | JKUN-GCKH-0857      |
|  |                      | DR:<br>FangSongLe                  | SCALE               |
|  | UNITS:<br>mm         |                                    | 1 : 1               |
|  |                      |                                    | SHEET<br>1 / 1      |