

A

B

C

D

E

F

REV	DESCRIPTION	DESIGN	DATE
A	NEW RELEASE	Fangsongle	2021/01/02

SCALE:1/2

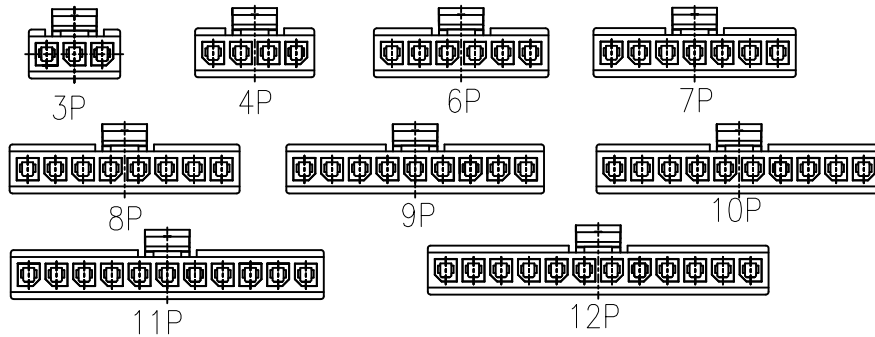
**Specifications:**

Poles: 02 to 12  
 Contact resistance:  $\leq 10\text{m}\Omega$   
 Insulation resistance:  $\geq 1000\text{M}\Omega$   
 Rated voltage: 250V AC DC  
 Rated current: 5.0A AC DC  
 Withstand Voltage: 1000V AC/minute  
 Temperature Range:  $-25^{\circ}\text{C} \sim +85^{\circ}\text{C}$   
 Material: PA66 UL94V-0, BLACK

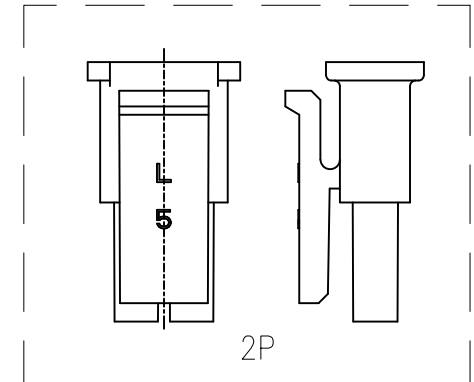
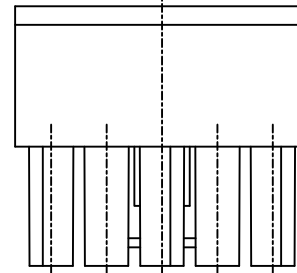
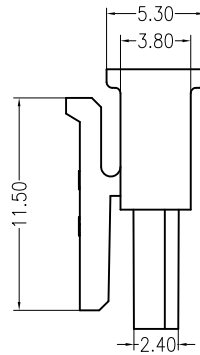
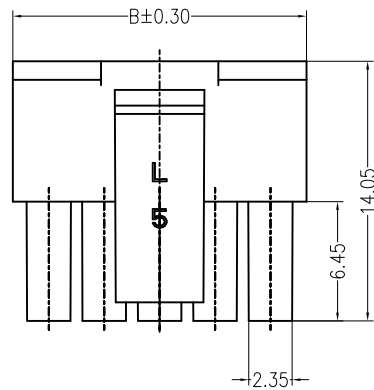
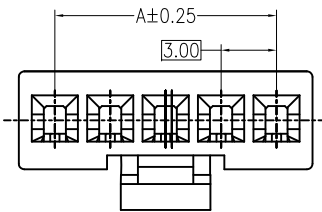
**ORDER INFORMATION:**

PART No. <u>                    </u>		PACKAGING: <u>                    </u>	
No. OF CIRCUITS: <u>                    </u>		PLASTIC MATERIAL: <u>                    </u>	
02-12		A7K=PA66	

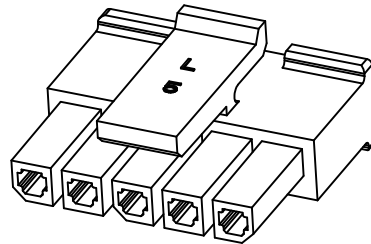
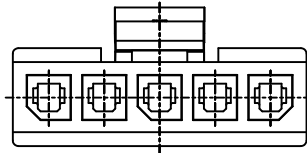

PIN.	DIM A	DIM B
2pin	3.00	6.90
3pin	6.00	9.90
4pin	9.00	12.90
5pin	12.00	15.90
6pin	15.00	18.90
7pin	18.00	21.90
8pin	21.00	24.90
9pin	24.00	27.90
10pin	27.00	30.90
11pin	30.00	33.90
12pin	33.00	36.90

**JKUN** 温州健坤接插件有限公司  
WENZHOU JKUN CONNECTOR CO.,LTD.

GENERAL TOLERANCE		USE:
X. ±0.50	X. ±5°	CUSTOMER
X.X ±0.30	X.X ±2°	APPD: Wangfeng
X.XX ±0.20	X.XX ±1°	CHKD: Zenglingqin
UNITS: mm		DR: Fangsongle

TITLE: 3.00mmPITCH Housing

PART NO.: A3001Y-\*\*-A7K-P

DWG NO.: JKUN-GCCP-0564

SCALE: 1 : 1 SHEET: 1 / 1

A

B

C

D

E

F