

REV	DESCRIPTION	DESIGN	DATE
A0	NEW RELEASE	Wudanping	2017/08/22
A1	Adjust flatness	Jiangjianyin	2020/06/18

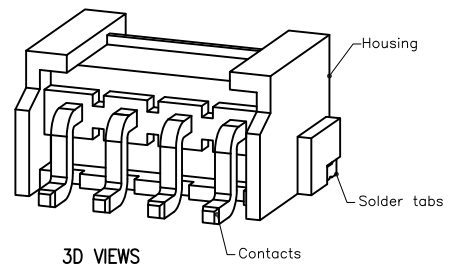
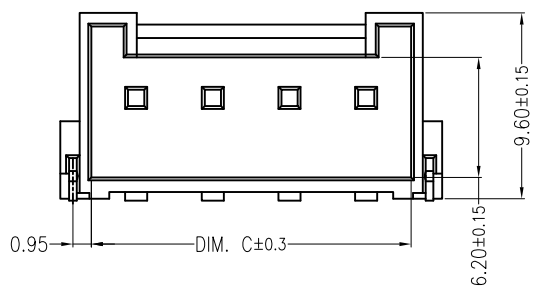
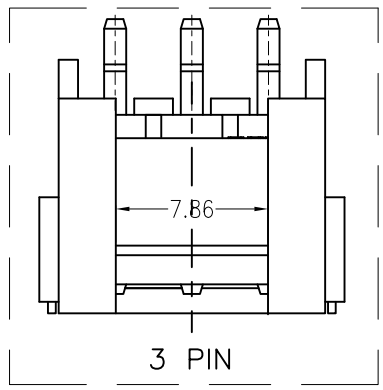
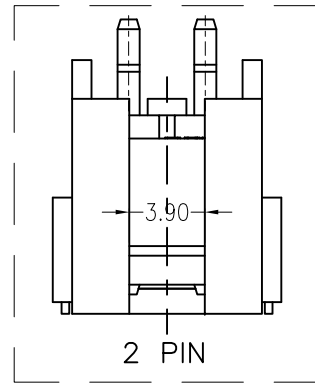
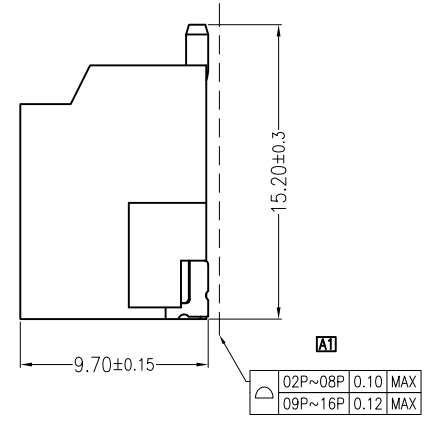
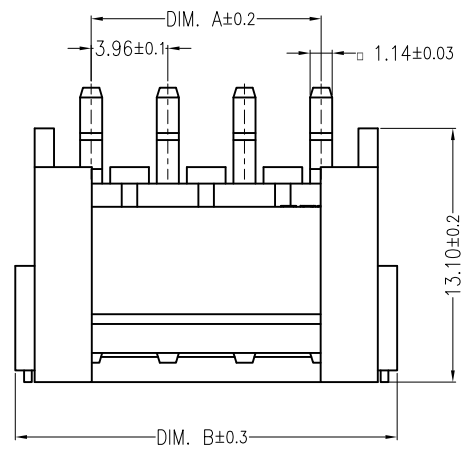

Specifications:

- Contact resistance: ≤20mΩ
- Insulation resistance: ≥1000MΩ
- Rated voltage: 250V AC DC
- Rated current: 7.0A AC DC
- Withstand voltage: 1500V AC/minute
- Temperature range: -25°C ~ +105°C
- Housing: PA9T, UL94V-0, Natural
- Contacts: Brass/Sn
- Solder tabs: Brass/Sn

ORDER INFORMATION:

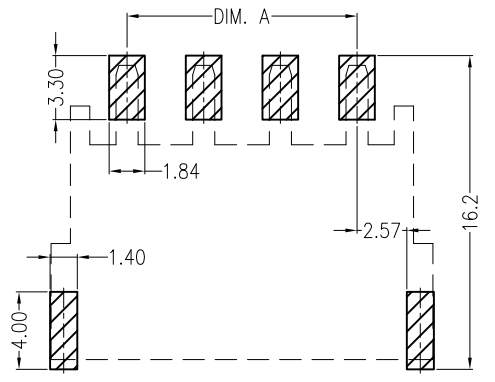
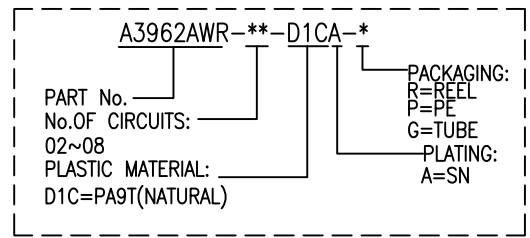

Circuits	Dimensions (mm)		
	DIM. A	DIM. B	DIM. C
02	3.96	11.88	8.60
03	7.92	15.84	12.56
04	11.88	19.80	16.52
05	15.84	23.76	20.48
06	19.80	27.72	24.44
07	23.76	31.68	28.40
08	27.72	35.64	32.36

JKUN 温州健坤接插件有限公司
WENZHOU JKUN CONNECTOR CO.,LTD.

GENERAL TOLERANCE		USE:
X. ±0.50	X. ±5°	CUSTOMER
X.X ±0.30	X.X ±2°	APPD: Shaojinghe
X.XX ±0.20	X.XX ±1°	CHKD: Zenglingqing
UNITS: mm	DR: Jiangjianyin	

TITLE: 3.96mmPITCH 90°WAFER SMT TYPE	
PART NO.: A3962AWR-**-D1CA-*	
DWG NO.: JKUN/GCKH-0576	
SCALE 1 : 1	SHEET 1 / 1