

REV	DESCRIPTION	DESIGN	DATE
A0	NEW RELEASE	FangSongLe	2020/04/06

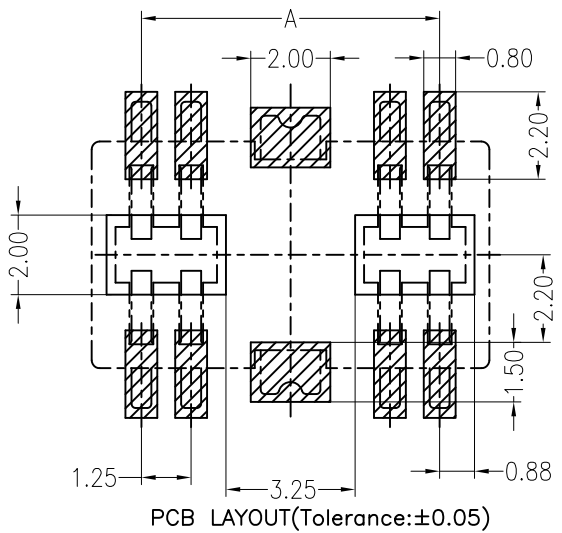

**Specifications:**  
 Contact resistance: ≤20mΩ  
 Insulation resistance: ≥1000MΩ  
 Rated voltage: 125V AC DC  
 Rated current: 1.0A AC DC  
 Withstand Voltage: 1000V AC/minute  
 Temperature Range: -25°C ~ +105°C  
 Housing: LCP UL94V-0, BEIGE  
 Contacts: Phosphor Bronze / MATTE Sn-plated

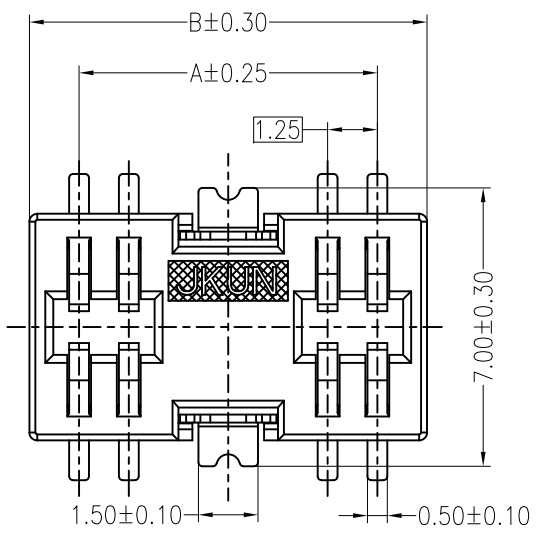
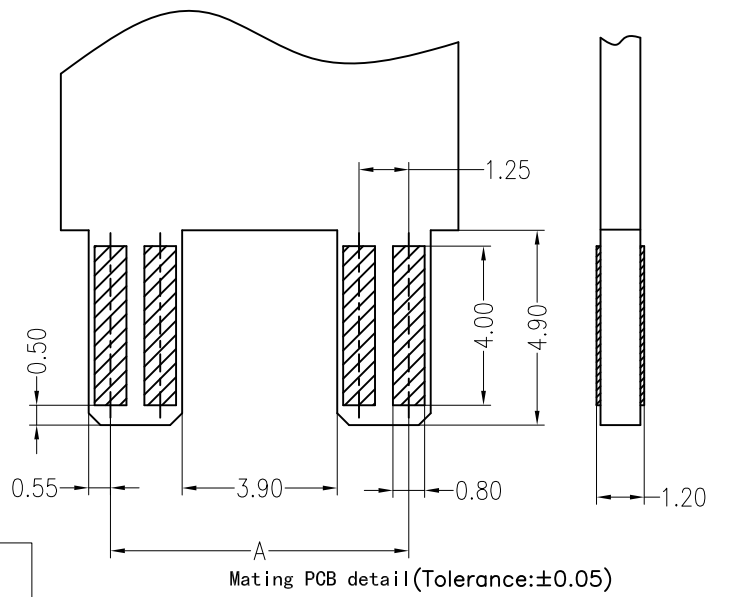
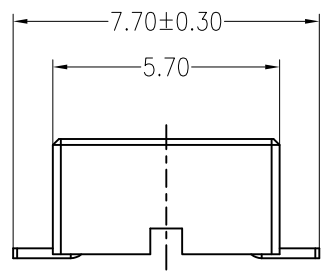
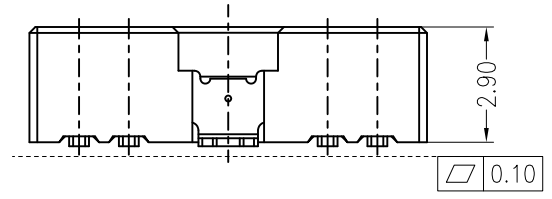

**ORDER INFORMATION:**  
**L1251AWV-2\*\*-F8MB1-R**

PART No. \_\_\_\_\_  
 No. OF CIRCUITS: 08-12  
 PLASTIC MATERIAL: F8M=LCP(BEIGE)

PACKAGING: R=REEL  
 Metal code: 1=PhosphorBronze  
 PLATING: B=MATTE Sn

PIN	DIM A	DIM B
*2x4	7.50	10.00
*2x6	10.00	12.50

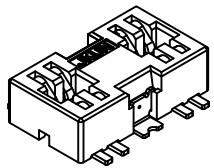
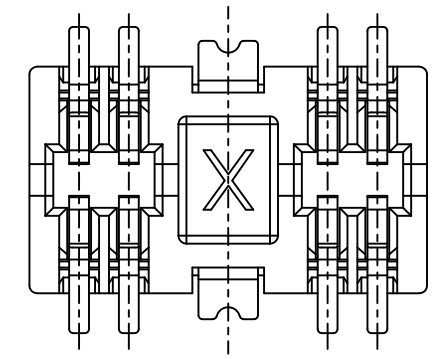

<b>JKUN</b> 温州健坤接插件有限公司 WENZHOU JKUN CONNECTOR CO.,LTD.		TITLE: -	
GENERAL TOLERANCE		USE: CUSTOMER	PART NO.: L1251AWV-2**-F8MB1-R
X. ±0.50	X. ±5'	APPD: Liuzhengling	DWG NO.: JKUN-GCKH-2024
X.X ±0.30	X.X ±2'	CHKD: Steven	SCALE 1 : 1
X.XX ±0.20	X.XX ±1'	DR: FangSongLe	SHEET 1 / 1
UNITS: mm			