

REV	DESCRIPTION	DESIGN	DATE
A	NEW RELEASE	Lingqing	2021/06/02

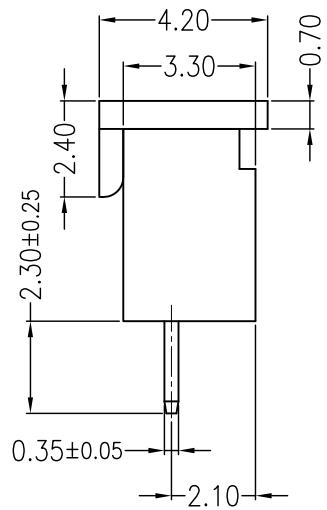

Specifications:
 Contact resistance: ≤20mΩ
 Insulation resistance: ≥100MΩ
 Rated voltage: 125V AC DC
 Rated current: 1.0A AC DC
 Withstand voltage: 500V AC/minute
 Temperature range: -25°C ~ +105°C
 Housing: LCP UL94V-0, Natural
 Cap: LCP UL94V-0, Natural
 Contacts: Brass/Sn-plated

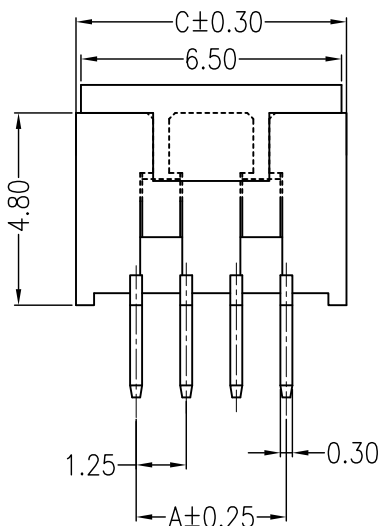
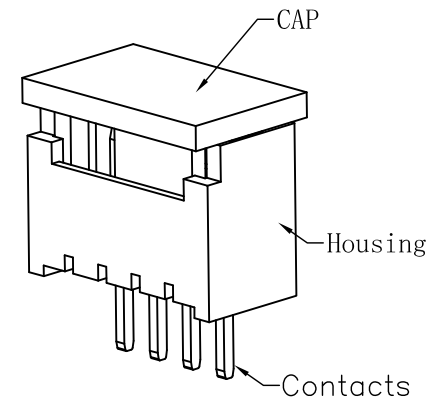
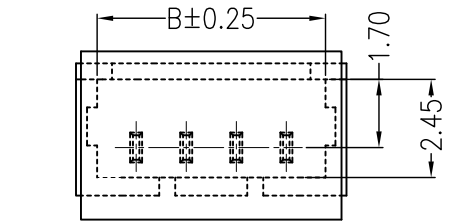
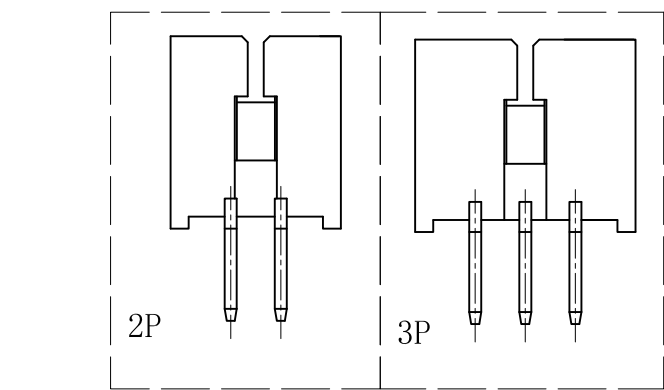
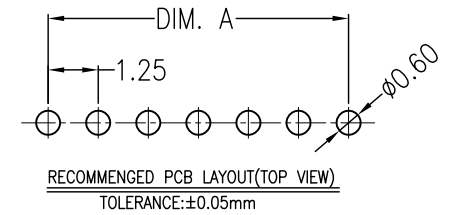

ORDER INFORMATION:

T1251A-**-****2-R-X

PART No. _____ X=CAP
 No. OF CIRCUITS: _____ PACKAGING:
 02~16 _____ R=REEL
 PLASTIC MATERIAL: _____ Metal code:
 F1C=LCP(BEIGE) _____ 2=Brass
 F1K=LCP(BLACK) _____ PLATING:
 A=Sn-plated
 B=MATTE SN

Circuits	Dimensions (mm)		
	DIM. A	DIM. B	DIM. C
02	1.25	3.20	4.25
03	2.50	4.45	5.50
04	3.75	5.70	6.75
05	5.00	6.95	8.00
06	6.25	8.20	9.25
07	7.50	9.45	10.50
08	8.75	10.70	11.75
09	10.00	11.95	13.00
10	11.25	13.20	14.25
11	12.50	14.45	15.50
12	13.75	15.70	16.75
13	15.00	16.95	18.00
14	16.25	18.20	19.25
15	17.50	19.45	20.50
16	18.75	20.70	21.75

JKUN 温州健坤接插件有限公司
 WENZHOU JKUN CONNECTOR CO.,LTD.

GENERAL TOLERANCE		USE:
X. ±0.50	X. ±5°	CUSTOMER
X.X ±0.30	X.X ±2°	APPD: Shaojinghe
X.XX ±0.20	X.XX ±1°	CHKD: Fangsongle
UNITS: mm		DR: Zenglingqing

TITLE: 1.25mm pitch 180°Wafe PIP type	
PART NO.: T1251A-**-****2-R-X	
DWG NO.: JKUN-GCKH-0971	
SCALE 1 : 1	SHEET 1 / 1

REV	ECN No.	DESCRIPTION	DESIGN	DATE
A		Release	程永海	2022.08.22

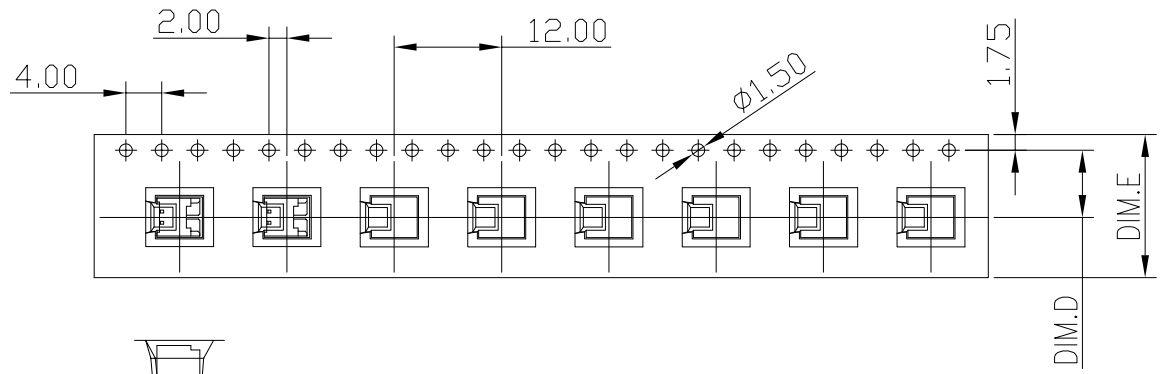

02~06 CONTACTS

产品引出方向

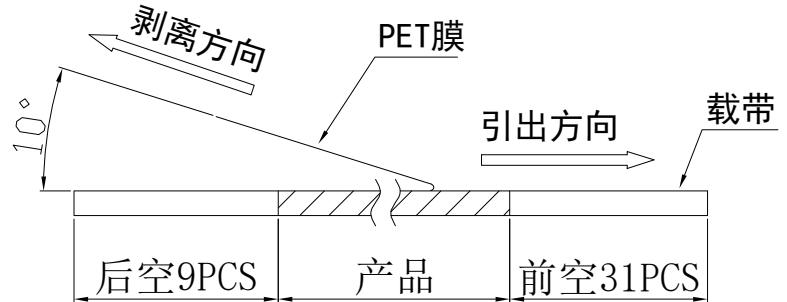

(PET膜剥离示意图)

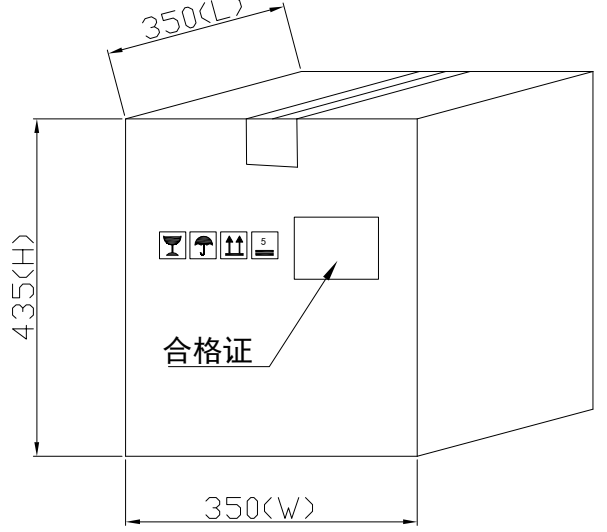
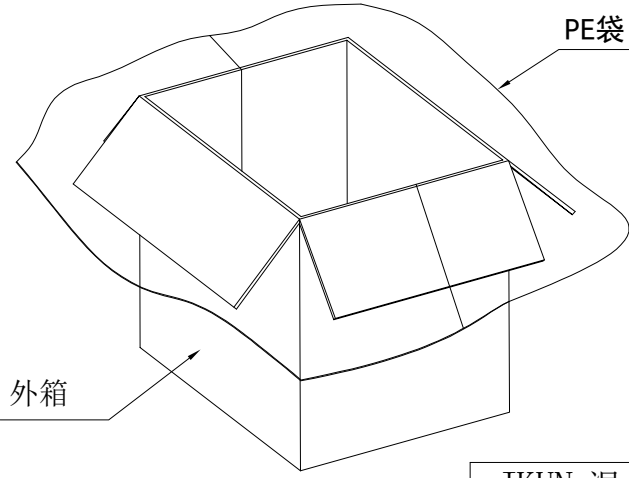
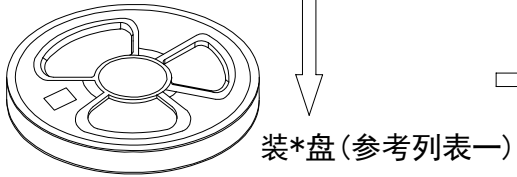
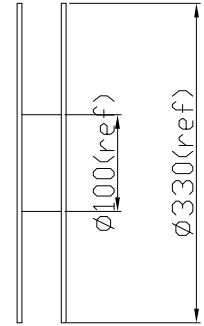
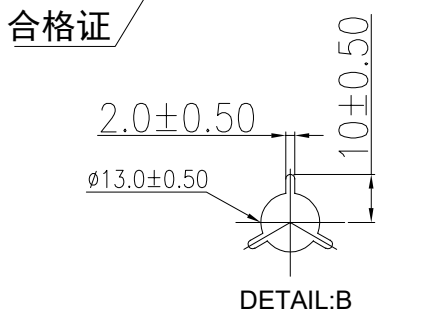
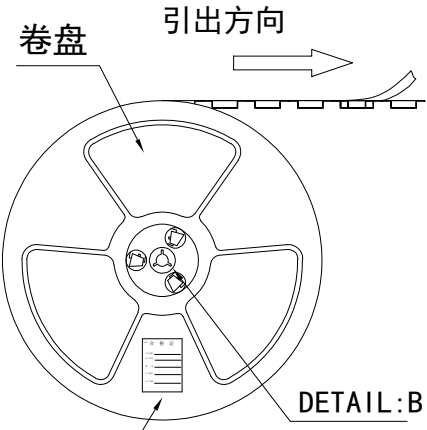

- 包装说明:
- 把成品包入卷盘中, 每盘装800PCS, 卷盘上贴上合格证, 将装好产品的卷盘放进外箱中, 外箱内先套一个大PE袋, 外箱上贴贴上合格证.
 - 所有材料有害物控制需符合RoHS标准.

列表一

Circuits	DIM. D	DIM. E	Q'ty/Reel	Packing (Reel/Caton)
02-06 PIN	7.5	16	800PCS	20/Reel

JKUN 温州健坤接插件有限公司 WENZHOU JKUN CONNECTOR CO., LTD.			TITLE: T1251AW	
X.± 0.5	X.±'	USE: MANUFACTURE	PART NO.:	
.X± 0.3	.X±'		T1251AW包装规范	
.XX± 0.25	.XX±'	APPD: 邵敬和	DWG NO.:	
--	--	CHKD: 蒋建银	JKUN-GCKH-0972	
UNITS: mm		DR: 程永海	SCALE 1 : 1	SHEET 1 / 1

REV	ECN No.	DESCRIPTION	DESIGN	DATE
A		Release	程永海	2022.11.12

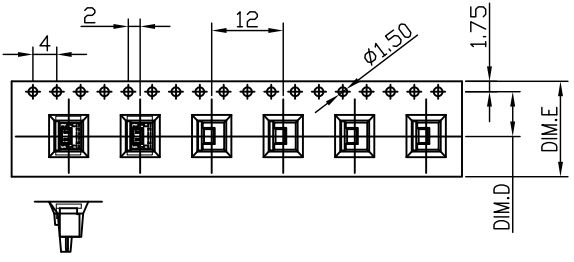

02~05 CONTACTS

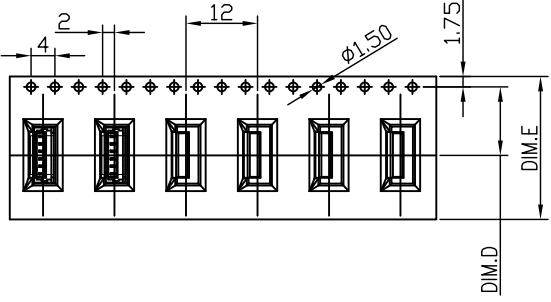

06 CONTACTS

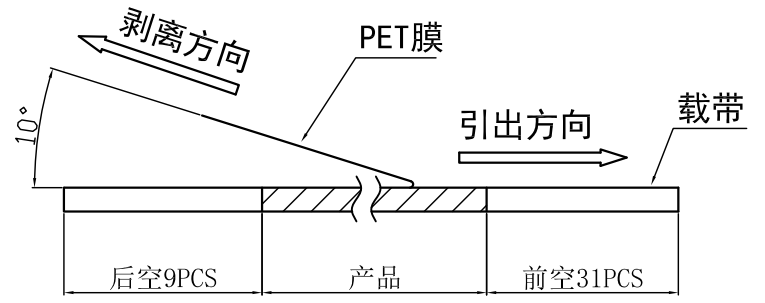

(PET膜剥离示意图)

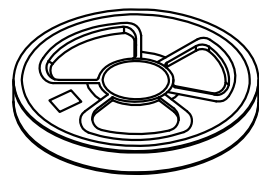
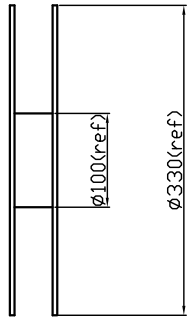
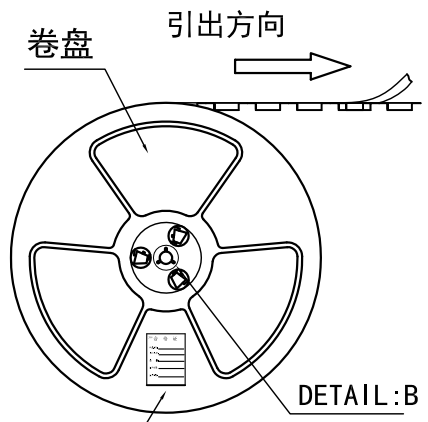

装*盘(参考列表一)

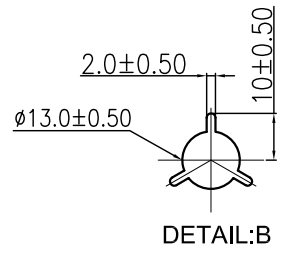
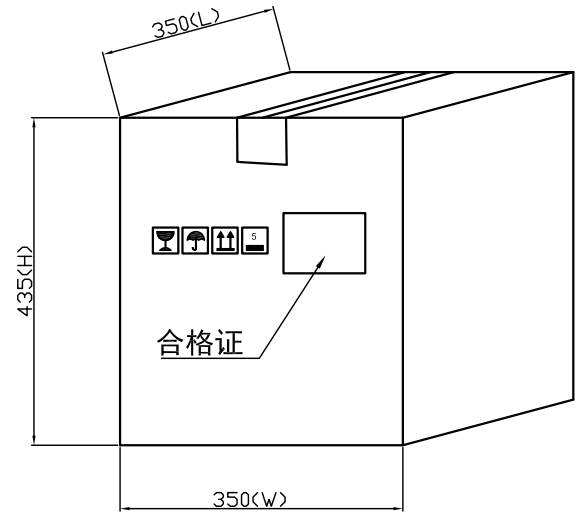
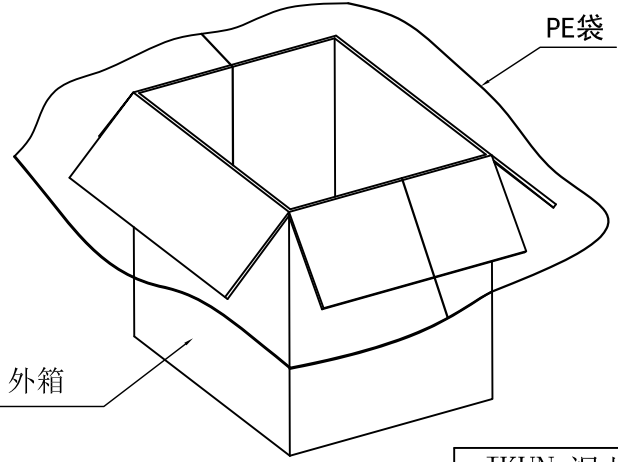

DETAIL:B

列表一

Circuits	DIM. D	DIM. E	Q'ty/Reel	Packing (Reel/Caton)
02-05 PIN	7.5	16	600PCS	20/Reel
06 PIN	11.5	24	600PCS	15/Reel

包装说明:

- 把成品包入卷盘中, 每盘装600PCS, 卷盘上贴上合格证, 将装好产品的卷盘放进外箱中, 外箱内先套一个大PE袋, 外箱上贴贴上合格证.
- 所有材料有害物控制需符合RoHS标准.

JKUN 温州健坤接插件有限公司 WENZHOU JKUN CONNECTOR CO., LTD.			TITLE: T1251A	
X.± 0.5	X.±*	USE: MANUFACTURE	PART NO.:	
.X± 0.3	.X±*	APPD: 朱志刚	T1251A包装规范	
.XX±0.25	.XX±*	CHKD: 蒋建银	DWG NO.:	
--	--	DR: 程永海	JKUN-GCKH-0971	
⊕	◁	UNITS: mm	SCALE 1 : 1	SHEET 1 / 1

REV	DESCRIPTION	DESIGN	DATE
A	NEW RELEASE	Lingqing	2021/06/02

Specifications:
 Contact resistance: $\leq 20m\Omega$
 Insulation resistance: $\geq 100M\Omega$
 Rated voltage: 125V AC DC
 Rated current: 1.0A AC DC
 Withstand voltage: 500V AC/minute
 Temperature range: $-25^{\circ}C \sim +105^{\circ}C$
 Housing: LCP UL94V-0, Natural
 Contacts: Brass/Sn-plated

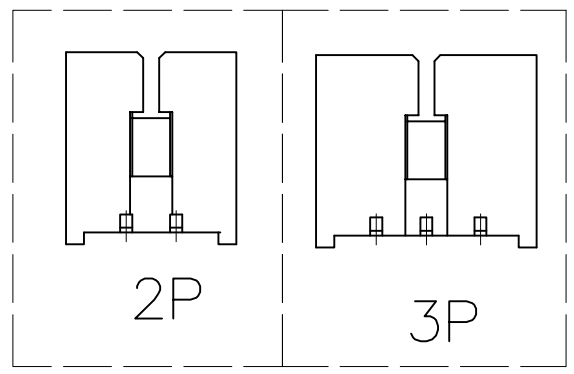
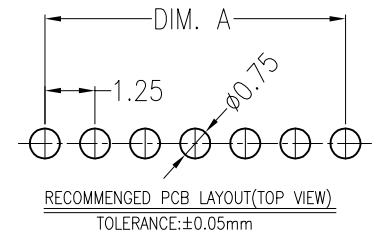
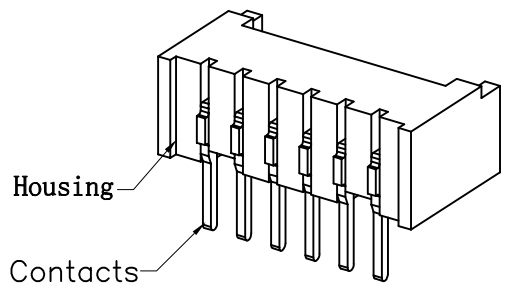
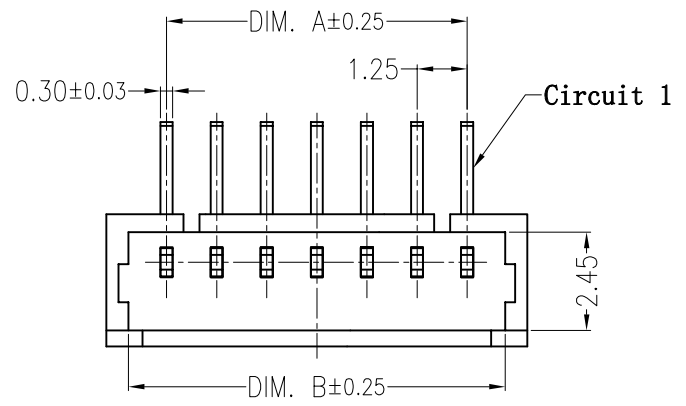
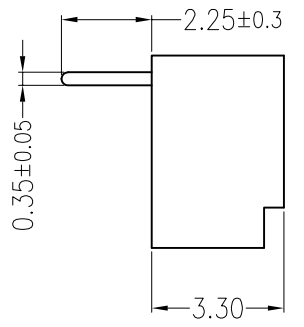
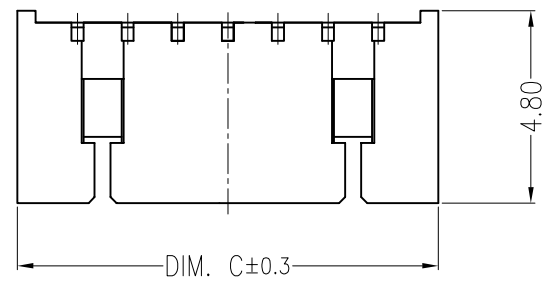

Circuits	Dimensions (mm)		
	DIM. A	DIM. B	DIM. C
02	1.25	3.20	4.25
03	2.50	4.45	5.50
04	3.75	5.70	6.75
05	5.00	6.95	8.00
06	6.25	8.20	9.25
07	7.50	9.45	10.50
08	8.75	10.70	11.75
09	10.00	11.95	13.00
10	11.25	13.20	14.25
11	12.50	14.45	15.50
12	13.75	15.70	16.75
13	15.00	16.95	18.00
14	16.25	18.20	19.25
15	17.50	19.45	20.50
16	18.75	20.70	21.75

ORDER INFORMATION:

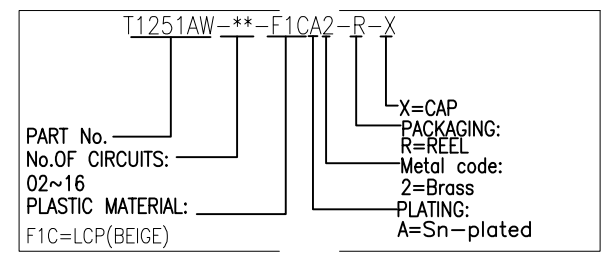

JKUN 温州健坤接插件有限公司
 WENZHOU JKUN CONNECTOR CO.,LTD.

GENERAL TOLERANCE	
X. ±0.50	X. ±5°
X.X ±0.30	X.X ±2°
X.XX ±0.20	X.XX ±1°

USE: CUSTOMER
 APPD: Shaojinghe
 CHKD: Fangsongle
 DR: Zenglingqing

TITLE: 1.25mm pitch 90°Wafe PIP type
 PART NO.: T1251AW-**-F1CA2-R-X
 DWG NO.: JKUN-GCKH-0972
 SCALE: 1 : 1
 SHEET: 1 / 1

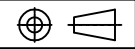

UNITS: mm