

REV	DESCRIPTION	DESIGN	DATE
A	NEW RELEASE	Lingqing	2020/11/20

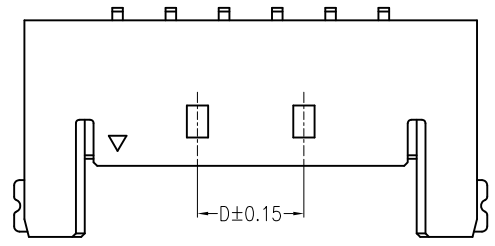

05P~12P Double Opening

Specifications:
 Contact resistance: ≤20mΩ
 Insulation resistance: ≥1000MΩ
 Rated voltage: 150V AC DC
 Rated current: 3.0A AC DC
 Withstand Voltage: 500V AC/minute
 Temperature Range: -25°C ~ +85°C
 Housing: PA6T UL94V-0, Black
 Contacts: Phosphor bronze Gold
 Solder Tabs: Phosphor bronze Matte Sn

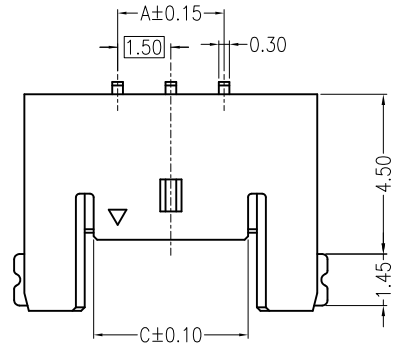
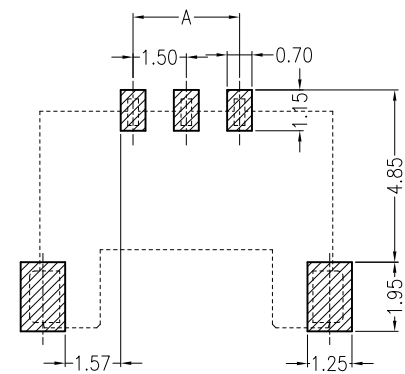
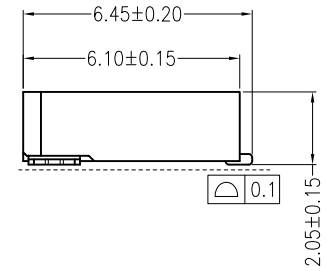
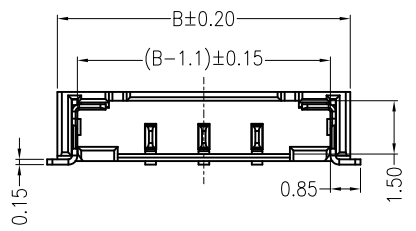

SUGGESTED PCB LAYOUT

Circuits	Dimensions (mm)			
	A	B	C	D
02	1.50	6.75	2.85	
03	3.00	8.25	4.35	
04	4.50	9.75	5.85	
05	6.00	11.25	7.35	3.00
06	7.50	12.75	8.85	3.00
07	9.00	14.25	10.35	4.50
08	10.50	15.75	11.85	6.00
09	12.00	17.25	13.35	7.50
10	13.50	18.75	14.85	9.00
11	15.00	20.25	16.35	10.50
12	16.50	21.75	17.85	12.00

ORDER INFORMATION:

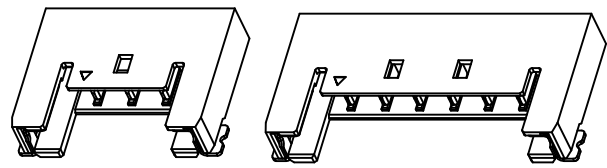
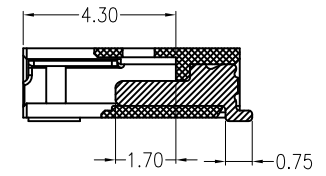
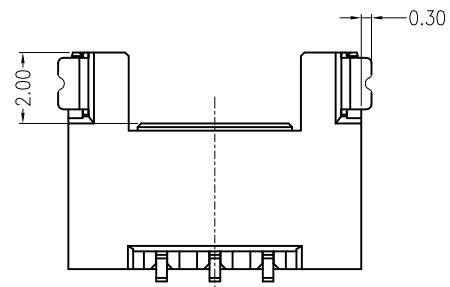
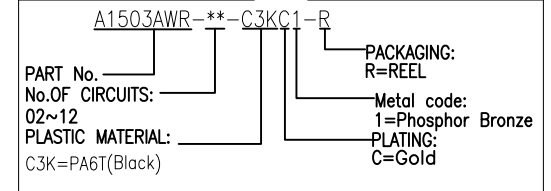

JKUN 温州健坤接插件有限公司 WENZHOU JKUN CONNECTOR CO.,LTD.		TITLE: 1.50 Pitch Wafer 90° SMT	
GENERAL TOLERANCE		USE: CUSTOMER	PART NO.:
X. ±0.50	X. ±5°	APPD: WangFeng	A1503AWR-**-C3KC1-R
X.X ±0.30	X.X ±2°	CHKD: Shaojinghe	DWG NO.:
X.XX ±0.20	X.XX ±1°	DR: Zenglingqing	JKUN-GCKH-0766
UNITS: mm		SCALE 1 : 1	SHEET 1 / 1

REV	DESIGN	DATE
A0	-	-
-	-	-

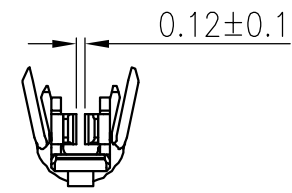
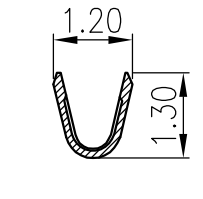
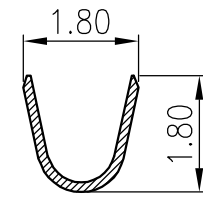
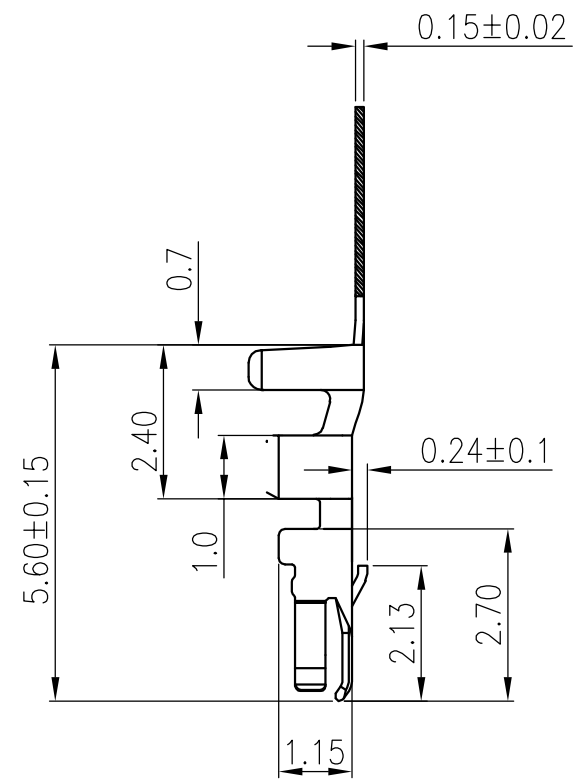
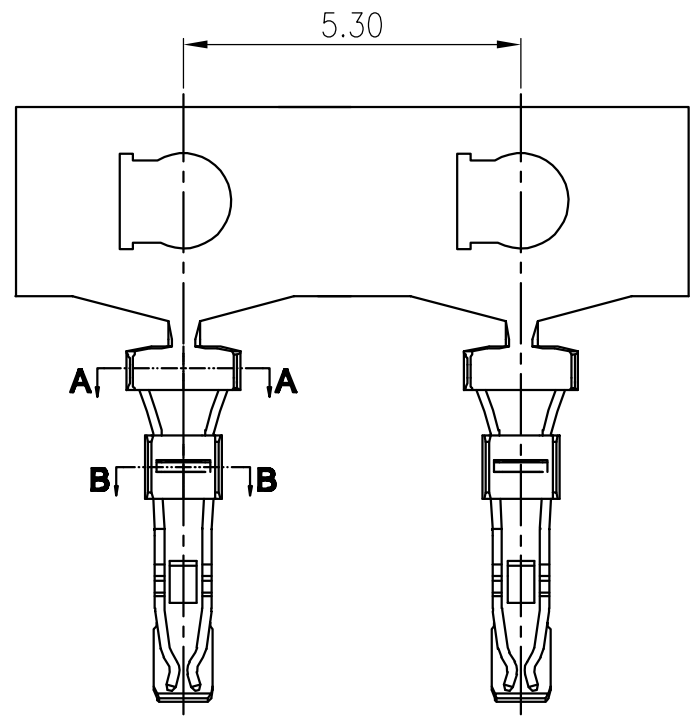

主要技术参数 Main Specifications

- 接触电阻 (Contact resistance): $\leq 20m\Omega$
- 绝缘电阻 (Insulation resistance): $\geq 1000M\Omega$
- 额定电压 (Rated voltage): 150V AC DC
- 额定电流 (Rated current): 3.0A AC DC
- 耐电压 (Withstand Voltage): 500V AC/minute
- 温度范围 (Temperature Range): $-25^{\circ}C \sim +85^{\circ}C$

Ordering Information & Specification:

Part No	Wire Range	Insulation O.D.	Material	Finish	Qty/Reel
A1503T-02端子	AWG #24~#28	1.10mm (MAX)	Phosphor bronze	GOLD-FLASH	/

JKUN 温州健坤接插件有限公司 WENZHOU JKUN CONNECTOR CO.,LTD.			TITLE: -	
X.±0.5	X.±5'	USE: CUSTOMER	PART NO.:	
.X±0.3	.X±2'		A1503T-02端子	
.XX±0.25	.XX±1'	APPD: 邵敬和	DWG NO.:	
--	--	CHKD: 田峰	JKUN-GCDZ-0084	
UNITS: mm		DR: 蒋建银	SCALE 1 : 1	SHEET 1 / 1

A | B | C | D | E | F

1

2

3

4

5

1

2

3

4

A | B | C | D | E | F

REV	ECN No.	DESCRIPTION	DESIGN	DATE
A0		Release	蒋建银	2018.11.23

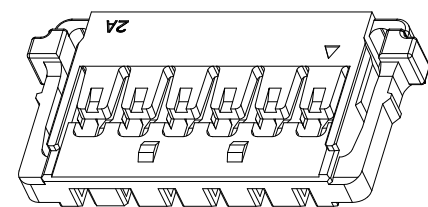
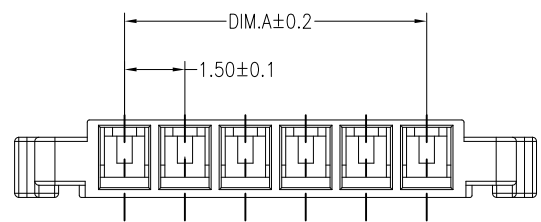

主要技术参数 Main Specifications

线 数 (Poles): 02 to 12
 接触电阻 (Contact resistance): $\leq 20m\Omega$
 绝缘电阻 (Insulation resistance): $\geq 1000M\Omega$
 额定电压 (Rated voltage): 150V AC DC
 额定电流 (Rated current): 3.0A AC DC
 耐 电 压 (Withstand Voltage): 500V AC/minute
 温度范围 (Temperature Range): $-25^{\circ}C \sim +85^{\circ}C$

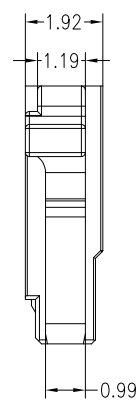
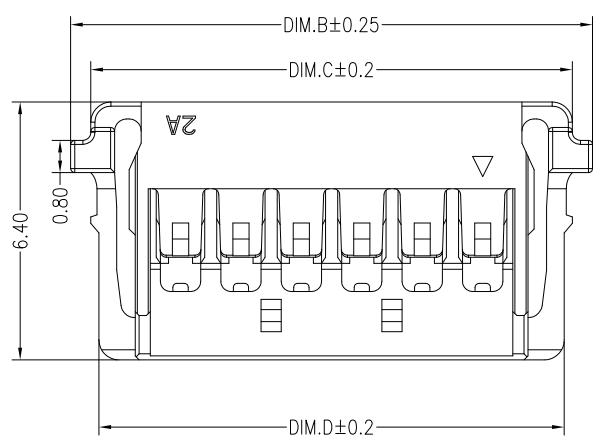

ORDER INFORMATION:

A1503Y--A5K-P**

PART No.		PACKAGING:	
No. OF CIRCUITS:		P=PE	
**		PLASTIC MATERIAL:	A5K=PA66 (BLACK)

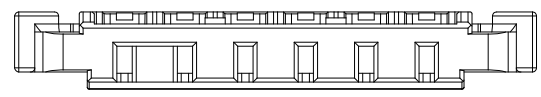

Poles	Dimensions(mm)			
	A	B	C	D
02	1.50	6.95	5.95	5.55
03	3.00	8.45	7.45	7.05
04	4.50	9.95	8.95	8.55
05	6.00	11.45	10.45	10.05
06	7.50	12.95	11.95	11.55
07	9.00	14.45	13.45	13.05
08	10.50	15.95	14.95	14.55
09	12.00	17.45	16.45	16.05
10	13.50	18.95	17.95	17.55
11	15.00	20.45	19.45	19.05
12	16.50	21.95	20.95	20.55

A	HOUSING	1 PCS	PA66	UL 94V-0, COLOR:BLACK
ITEM	COMPONENT	Q'TY	MATERIAL	FINISH
JKUN 温州健坤接插件有限公司 WENZHOU JKUN CONNECTOR CO., LTD.				TITLE: - 1.5mmPITCH 180°WAFER SMT TYPE
X.±0.5	X.±5'	USE:	CUSTOMER	
.X±0.3	.X±2'	APPD:	邵敬和	
.XX±0.25	.XX±1'	CHKD:	田峰	
--	--	DR:	蒋建银	
UNITS: mm		SCALE	SHEET	
		1 : 1	1 / 1	

REV	ECN No.	DESCRIPTION	DESIGN	DATE
A		Release	蒋建银	2017.06

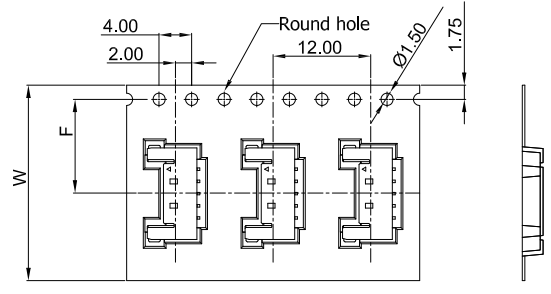

02~07 CONTACTS

产品引出方向
→

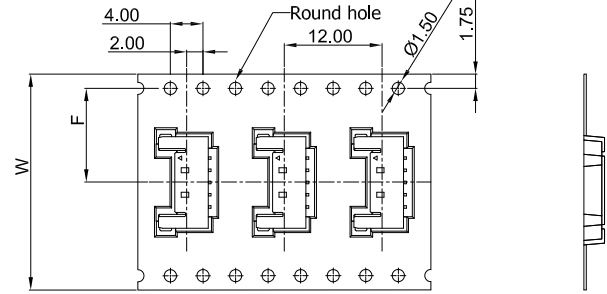

08~12 CONTACTS

产品引出方向
→

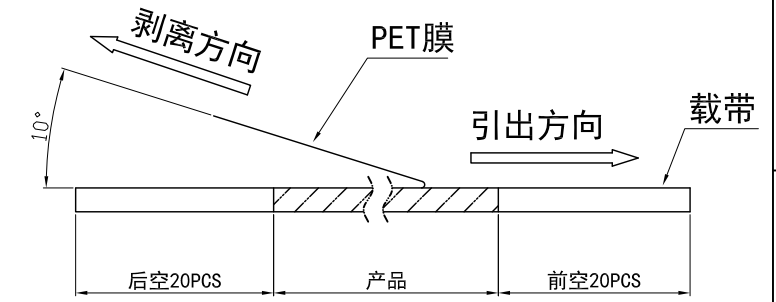

(PET膜剥离示意图)

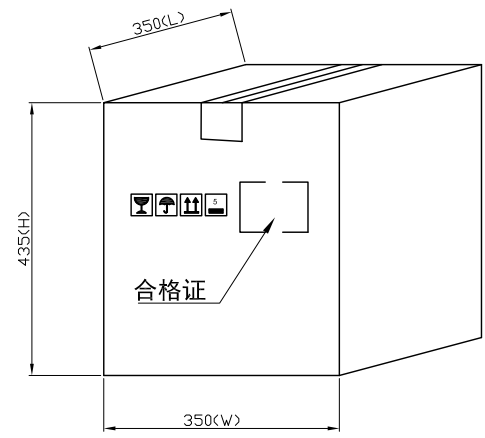
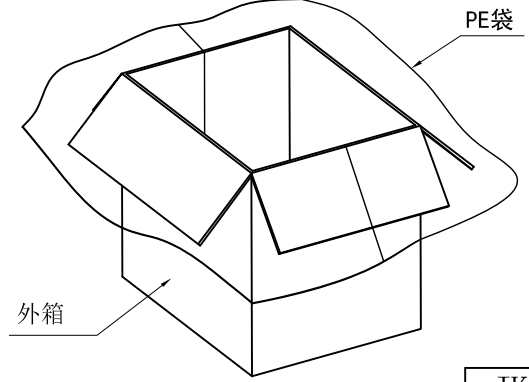
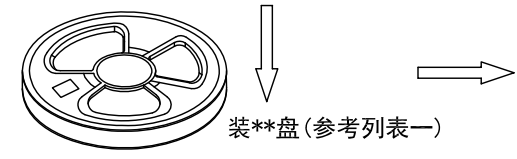
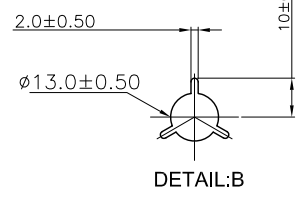
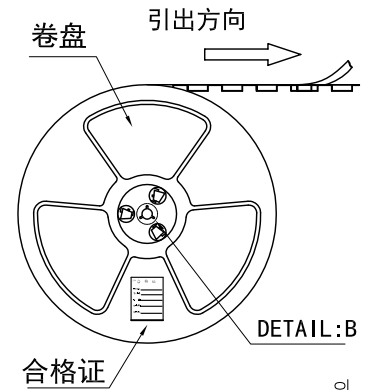

列表一

Circuits	F	W	Q'ty/Reel	Packing (Reel/Caton)
02~03PIN	7.50	16	2000PCS	20/Reel
04~07PIN	11.50	24	2000PCS	15/Reel
08~12PIN	14.20	32	2000PCS	11/Reel

包装说明:

- 把成品包入卷盘中, 每盘装2000PCS, 卷盘上贴上合格证, 将装好产品的卷盘放进外箱中, 外箱内先套一个大PE袋, 外箱上贴贴上合格证。
- 所有材料有害物控制需符合RoHS标准。

JKUN 温州健坤接插件有限公司 WENZHOU JKUN CONNECTOR CO., LTD.			TITLE: 包装规范	
X.± 0.5	X.±'	USE: MANUFACTURE	PART NO.: A1503AWR 卷装	
.X± 0.3	.X±'		DWG NO.: JKUN/GCBZ-0766	
.XX±0.25	.XX±'	APPD: 邵敬和	SCALE 1 : 1	
--	--	CHKD: 曾令青	SHEET 1 / 1	
⊕	◁	UNITS: mm	DR: 蒋建银	