

A B C D E F

REV	DESCRIPTION	DESIGN	DATE
A0	NEW RELEASE	FangSongLe	2020/08/03

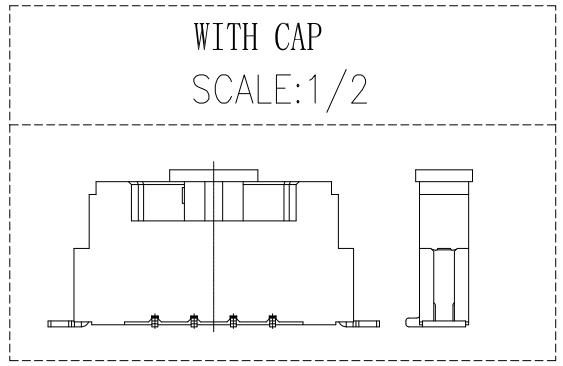

Specifications:
 Contact resistance: ≤20mΩ
 Insulation resistance: ≥1000MΩ
 Rated voltage: 250V AC DC
 Rated current: 1.0A AC DC
 Withstand Voltage: 1000V AC/minute
 Temperature Range: -25°C ~ +105°C
 Housing: LCP UL94V-0, BEIGE
 Contacts: PhosphorBronze / Sn-plated

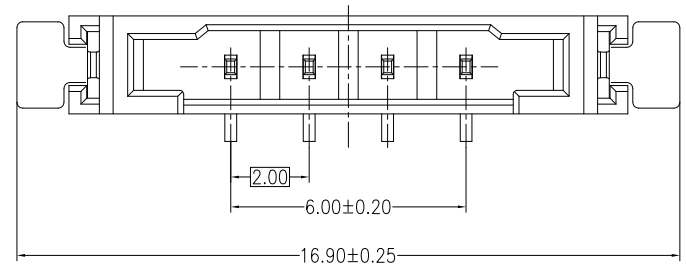
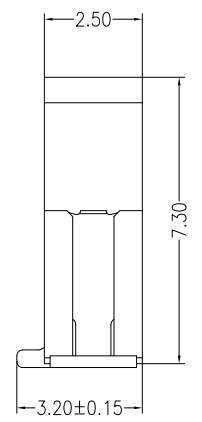
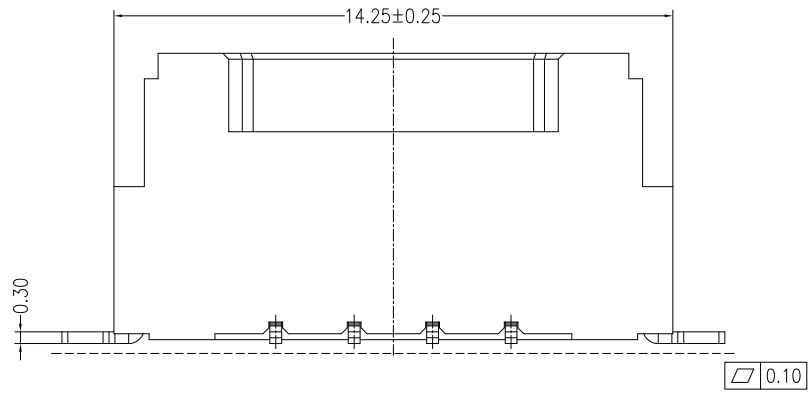

ORDER INFORMATION:

A2011AWV-04-F3MA1-R-X

PART No. _____
 No. OF CIRCUITS: _____
 04
 PLASTIC MATERIAL: _____
 F3M=LCP (BEIGE)

X: CAP
 PACKAGING:
 R=REEL
 Metal code:
 1=PhosphorBronze
 PLATING:
 A=Sn

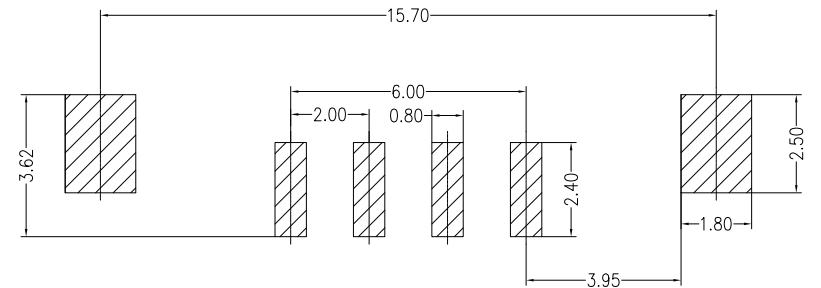

PCB Layout

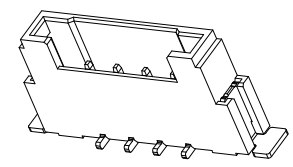
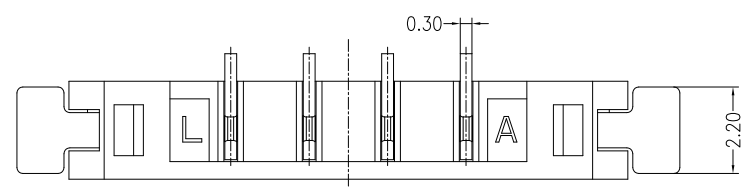

A B C D E F

JKUN 温州健坤接插件有限公司 WENZHOU JKUN CONNECTOR CO.,LTD.		TITLE: 2.00 Pitch Wafer180° SMT	
GENERAL TOLERANCE		USE: CUSTOMER	PART NO.:
X. ±0.50	X. ±5°	APPD: WangFeng	A2011AWV-04-F3MA1-R-X
X.X ±0.30	X.X ±2°	CHKD: Steven	DWG NO.:
X.XX ±0.20	X.XX ±1°	DR: FangSongLe	JKUN-GCKH-0857
UNITS: mm		SCALE 1 : 1	SHEET 1 / 1

REV	ECN No.	DESCRIPTION	DESIGN	DATE
A		Release	蒋建银	2020.09.21

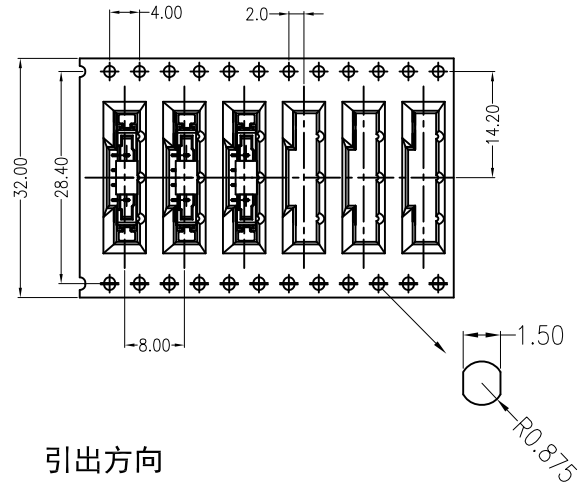

04 CONTACTS
产品引出方向

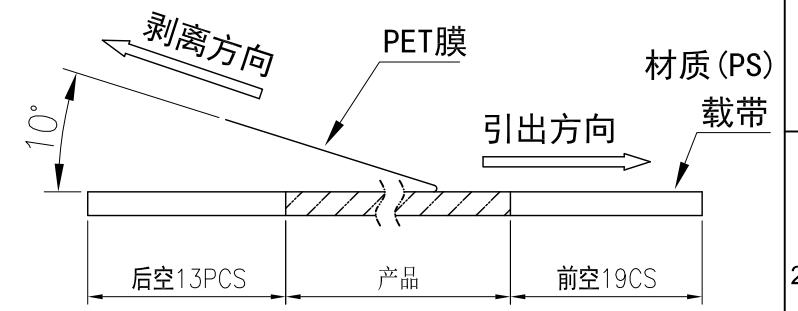

(PET膜剥离示意图)

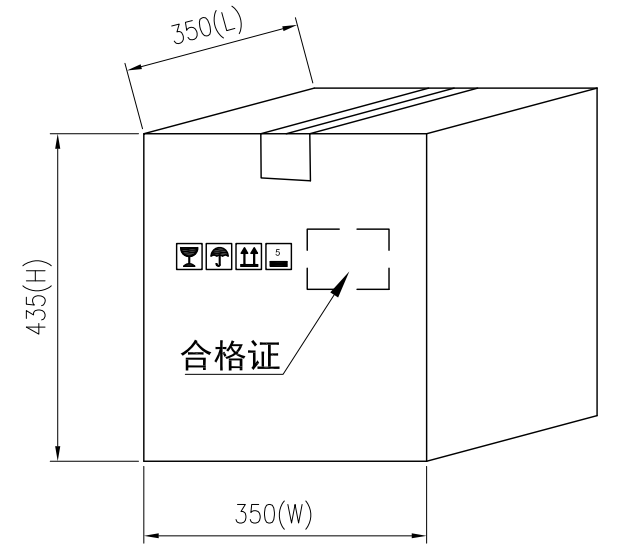
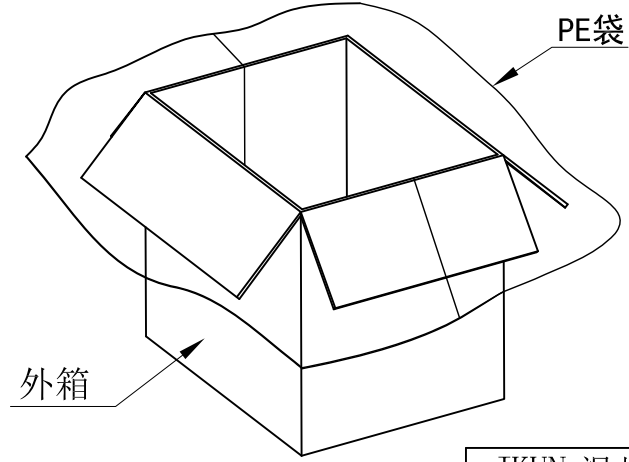
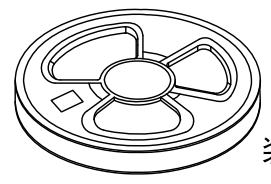
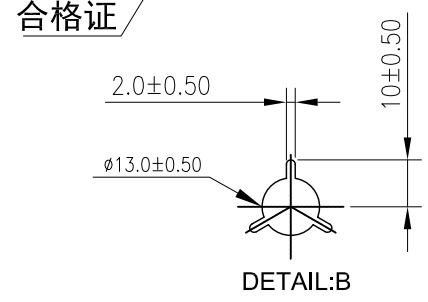
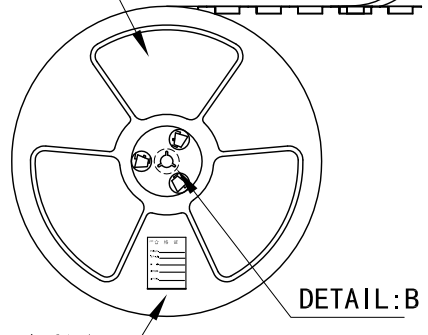
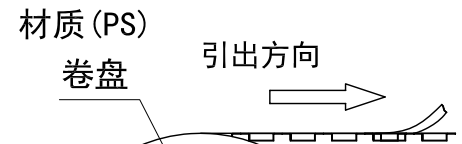

- 包装说明:
- 把成品包入卷盘中, 每盘装1000PCS, 卷盘上贴上合格证, 将装好产品的卷盘放进外箱中, 外箱内先套一个大PE袋, 外箱上贴贴上合格证.
 - 所有材料有害物控制需符合RoHS标准.

列表一

Circuits	DIM. D	DIM. E	Q'ty/Reel	Packing (Reel/Caton)
04PIN	14.20	32	1000PCS	11/Reel

JKUN 温州健坤接插件有限公司 WENZHOU JKUN CONNECTOR CO., LTD.			TITLE: A2011AWV	
X.± 0.5	X.±*	USE: MANUFACTURE	PART NO.:	
.X± 0.3	.X±*		A2011AWV-04 卷装规范	
.XX± 0.25	.XX±*	APPD: 王锋	DWG NO.:	
--	--	CHKD: 方松乐	JKUN/GCBZ-0857	
⊕	∠	UNITS: mm	DR: 蒋建银	SCALE 1 : 1
				SHEET 1 / 1