

REV	DESCRIPTION	DESIGN	DATE
A	NEW RELEASE	Lingqing	2021/06/02
B	Change the needle length	Lingqing	2022/03/16

Circuits	Dimensions (mm)		
	A	B	C
02	1.50	3.60	4.50
03	3.00	5.10	6.00
04	4.50	6.60	7.50
05	6.00	8.10	9.00
06	7.50	9.60	10.50
07	9.00	11.10	12.00
08	10.50	12.60	13.50
09	12.00	14.10	15.00
10	13.50	15.60	16.50
11	15.00	17.10	18.00
12	16.50	18.60	19.50
13	18.00	20.10	21.00
14	19.50	21.60	22.50
15	21.00	23.10	24.00
16	22.50	24.60	25.50

Specifications:
 Contact resistance: $\leq 20m\Omega$
 Insulation resistance: $\geq 500M\Omega$
 Rated voltage: 125V AC DC
 Rated current: 1.0A AC DC
 Withstand voltage: 500V AC/minute
 Temperature range: $-25^{\circ}C \sim +105^{\circ}C$
 Housing: LCP UL94V-0, Natural
 Cap: PA9T UL94V-0, Natural
 Contacts: Brass/Sn-plated

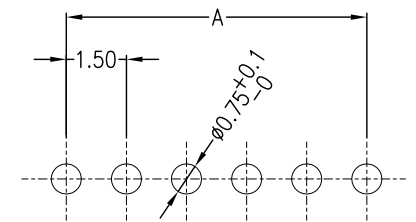

RECOMMENDED PCB LAYOUT(TOP VIEW)
 TOLERANCE: $\pm 0.05mm$

ORDER INFORMATION:

T1502A-**-F1CA2-R-X

PART No. _____
 No.OF CIRCUITS: _____
 02~16
 PLASTIC MATERIAL: _____
 F1C=LCP(BEIGE)

X=CAP
 PACKAGING:
 R=REEL
 Metal code:
 2=Brass
 PLATING:
 A=Sn-plated

JKUN 温州健坤接插件有限公司 WENZHOU JKUN CONNECTOR CO.,LTD.		TITLE: 1.50mm pitch 180°Wafer DIP type	
GENERAL TOLERANCE		USE: CUSTOMER	PART NO.:
X. ± 0.50	X. $\pm 5^{\circ}$	APPD: Shaojinghe	T1502A-**-F1CA2-R-X
X.X ± 0.30	X.X $\pm 2^{\circ}$	CHKD: Fangsongle	DWG NO.:
X.XX ± 0.20	X.XX $\pm 1^{\circ}$	DR: Zenglingqing	JKUN-GCKH-0924
UNITS: mm		SCALE 1 : 1	SHEET 1 / 1

REV	DESCRIPTION	DESIGN	DATE
A	NEW RELEASE	Lingqing	2021/02/23

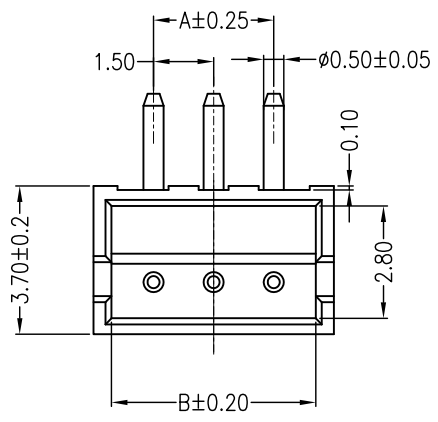
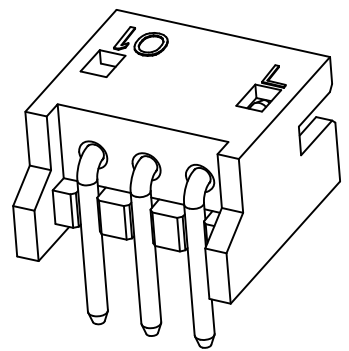
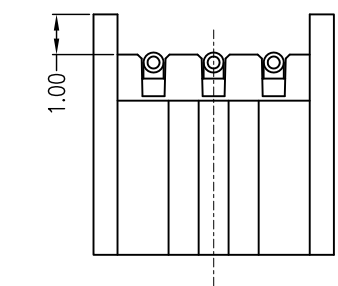

Circuits	Dimensions (mm)		
	A	B	C
02	1.50	3.60	4.50
03	3.00	5.10	6.00
04	4.50	6.60	7.50
05	6.00	8.10	9.00
06	7.50	9.60	10.50
07	9.00	11.10	12.00
08	10.50	12.60	13.50
09	12.00	14.10	15.00
10	13.50	15.60	16.50
11	15.00	17.10	18.00
12	16.50	18.60	19.50
13	18.00	20.10	21.00
14	19.50	21.60	22.50
15	21.00	23.10	24.00
16	22.50	24.60	25.50

Specifications:
 Contact resistance: ≤20mΩ
 Insulation resistance: ≥500MΩ
 Rated voltage: 125V AC DC
 Rated current: 1.0A AC DC
 Withstand voltage: 500V AC/minute
 Temperature range: -25°C ~ +105°C
 Housing: LCP UL94V-0, Natural
 Contacts: Brass/Sn-plated

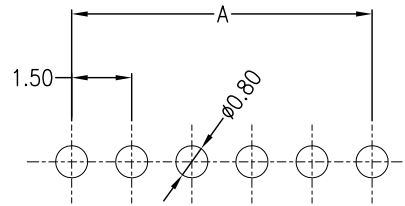

RECOMMENDED PCB LAYOUT (TOP VIEW)
 TOLERANCE: ±0.05mm

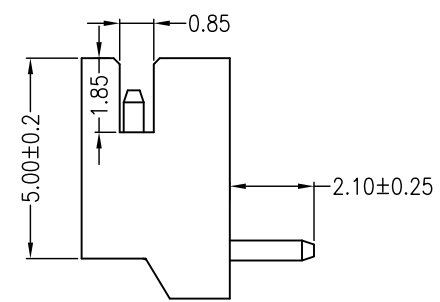
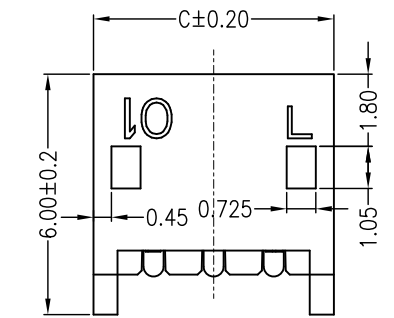

ORDER INFORMATION:

T1502AWD-**-F1CA2-R

PART No. _____
 No. OF CIRCUITS: _____
 02~16
 PLASTIC MATERIAL: _____
 F1C=LCP(BEIGE)

PACKAGING:
 R=REEL
 Metal code:
 2=Brass
 PLATING:
 A=Sn-plated

JKUN 温州健坤接插件有限公司 WENZHOU JKUN CONNECTOR CO.,LTD.		TITLE: 1.50mm pitch 90°Wafe DIP type	
GENERAL TOLERANCE		USE: CUSTOMER	PART NO.:
X. ±0.50	X. ±5°	APPD: Zhangzhongyong	T1502AWD-**-F1CA2-R
X.X ±0.30	X.X ±2°	CHKD: Fangsongle	DWG NO.:
X.XX ±0.20	X.XX ±1°	DR: Zenglingqing	JKUN-GCKH-0925
⊕	UNITS: mm	SCALE 1 : 1	SHEET 1 / 1

REV	ECN No.	DESCRIPTION	DESIGN	DATE
A		Release	程永海	2022.03.16

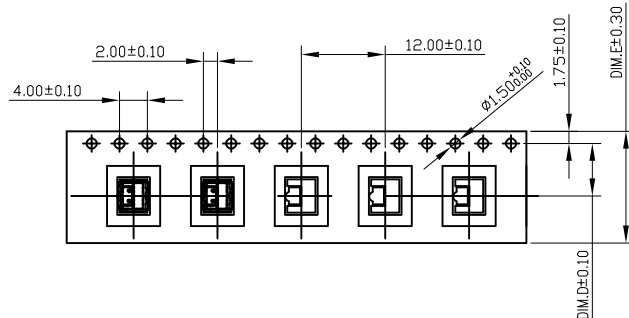

02~06 CONTACTS

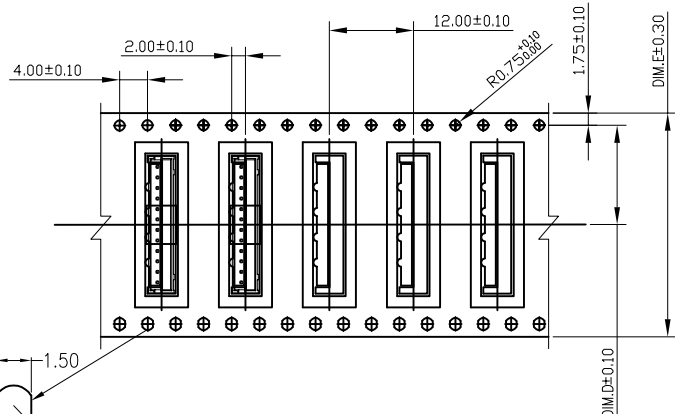

12 CONTACTS

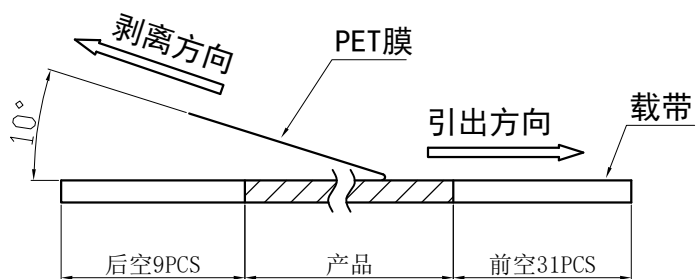

(PET膜剥离示意图)

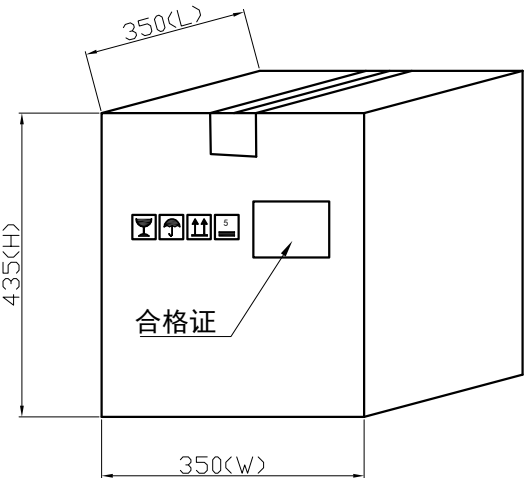
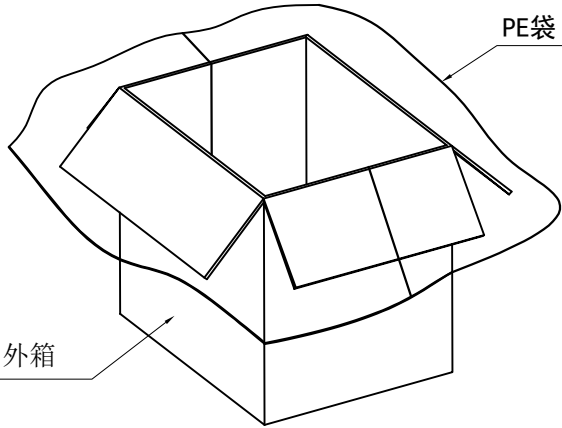
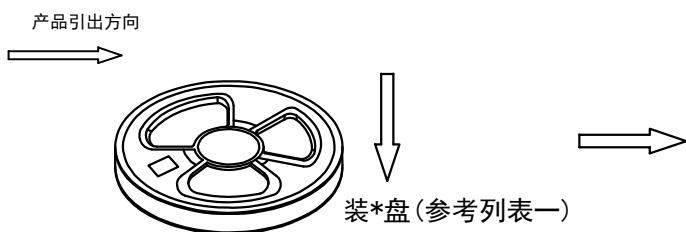
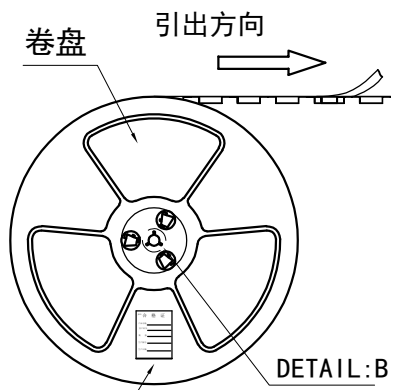

列表一

Circuits	DIM. D	DIM. E	Q'ty/Reel	Packing (Reel/Caton)
02-04 PIN	7.5	16	600PCS	20/Reel
05-06 PIN	11.5	24	600PCS	15/Reel
12 PIN	14.2	32	600PCS	11/Reel

包装说明:

- 把成品包入卷盘中, 每盘装600PCS, 卷盘上贴上合格证, 将装好产品的卷盘放进外箱中, 外箱内先套一个大PE袋, 外箱上贴贴上合格证.
- 所有材料有害物控制需符合RoHS标准.

JKUN 温州健坤接插件有限公司 WENZHOU JKUN CONNECTOR CO., LTD.			TITLE: T1502A	
X.± 0.5	X.±'	USE: MANUFACTURE	PART NO.:	
.X± 0.3	.X±'		T1502A包装规范	
.XX± 0.25	.XX±'	APPD: 邵敬和	DWG NO.:	
--	--	CHKD: 蒋建银	JKUN-GCKH-0924	
UNITS: mm		DR: 程永海	SCALE 1 : 1	SHEET 1 / 1